

PANTA REI TELE-T

telescopico a trascinamento/dragging telescopic



PANTA REI sistema per porte scorrevoli a due e a tre ante telescopiche con movimento a trascinamento, con e senza vetro fisso, per fissaggio a parete e a soffitto
Utilizza il sistema di profili modulare rotaia-fermavetro-copertina PANTA REI
Il movimento a trascinamento consente l'apertura e la chiusura di tutte le ante scorrevoli in successione agendo sulla maniglia
Disponibili differenti kit, con e senza foratura del vetro

PANTA REI dragging telescopic motion system for two and three sliding doors with or without fixed glass, for wall or ceiling fixing
Uses the PANTA REI modular sliding door track and profiles system
The dragging movement allows the sequential opening and closing of all sliding doors acting on the handle
Different sets available, with and without glass cutouts

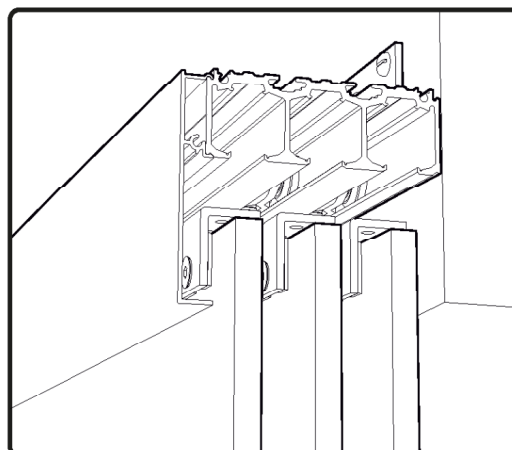

PRTT2-80

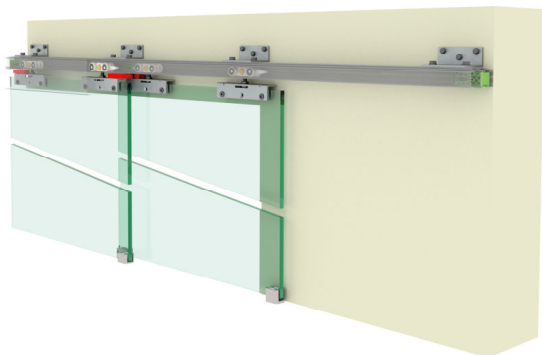

PANTA REI TELE-T kit 2 ante scorrevoli telescopiche a trascinamento per fissaggio a parete e a soffitto costituito da:
4 pinze basso profilo SD03, 4 carrelli in Nylon®, 3 staffe di trascinamento, 3 fincorsa regolabili PR2207, 1 guida pavimento SDL01, 1 guida mobile doppia SDZ01
Disponibile in versione destra (cod. PRTT2-80-DX) e sinistra (cod. PRTT2-80-SX)
DA USARSI CON COPERTINA PRC02L

PANTA REI TELE-T 2 leaves dragging telescopic sliding door set composed of:
4 SD03 low profile clamps, 4 Nylon® carriages, 3 dragging brackets, 3 adjustable PR2207 wheel stops, 1 SDL01 floor guide, 1 SDZ01 floating double guide
Right (code PRTT2-80-DX) and left (PRTT2-80-SX) models available
USE WITH PRC02L COVER

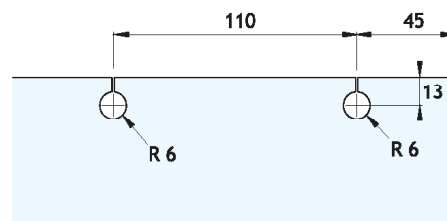
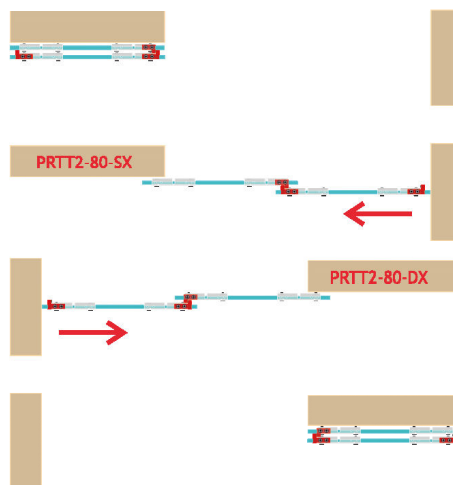

PRTT3-80

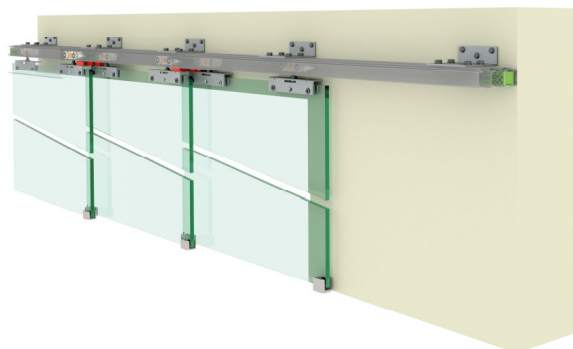

PANTA REI TELE-T kit 3 ante scorrevoli telescopiche a trascinamento per fissaggio a parete e a soffitto costituito da:
6 pinze basso profilo SD03, 6 carrelli in Nylon®, 4 staffe di trascinamento, 4 finecorsa regolabili PR2207, 1 guida pavimento SDL01, 2 guide mobili doppie SDGZ01
Disponibile in versione destra (cod. PRTT3-80-DX) e sinistra (cod. PRTT3-80-SX)
DA USARSI CON COPERTINA PRC02L

PANTA REI TELE-T 3 leaves dragging telescopic sliding door set composed of:
6 SD03 low profile clamps, 6 Nylon® carriages, 4 dragging brackets, 4 adjustable PR2207 wheel stops, 1 SDL01 floor guide, 2 SDZ01 floating double guide
Right (code PRTT3-80-DX) and left (PRTT3-80-SX) models available
USE WITH PRC02L COVER

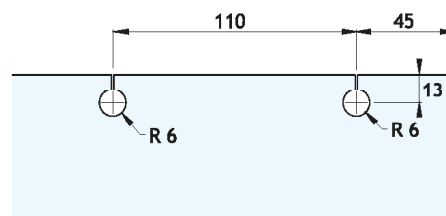
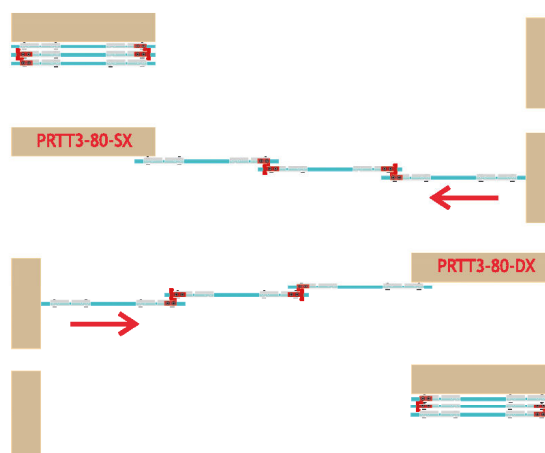

↓ 8-13 ↑	← MIN 450 →	MAX KG 80	AA	BX	XA
----------------	----------------------	-----------------	----	----	----

PRTT2-100



PANTA REI TELE-T kit 2 ante scorrevoli telescopiche a trascinamento costituito da:
4 pinze senza tacca a basso profilo SD07, 4 carrelli in Nylon®, 3 staffe di
trascinamento, 3 finecorsa regolabili PR2207, 1 guida pavimento SDL01, 1 guida
mobile doppia SDZ01

Disponibile in versione destra (cod. PRTT2-100-DX) e sinistra (cod. PRTT3-100-SX)
DA USARSI CON COPERTINA PRC02L

PANTA REI TELE-T 2 leafs dragging telescopic sliding door set composed of:
4 SD07 no cut-out low profile clamps, 4 Nylon® carriages, 3 dragging brackets, 3
adjustable PR2207 wheel stops, 1 SDL01 floor guide, 1 SDZ01 floating double guide
Right (code PRTT2-100-DX) and left (PRTT2-100-SX) models available
USE WITH PRC02L COVER

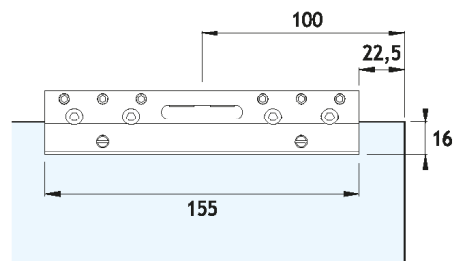
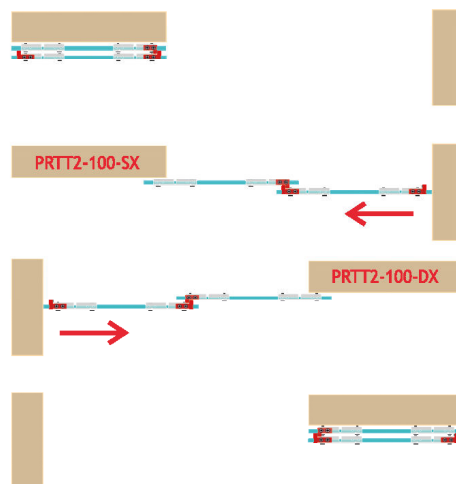

PRTT3-100



PANTA REI TELE-T kit 3 ante scorrevoli telescopiche a trascinamento costituito da:
6 pinze senza tacca a basso profilo SD07, 6 carrelli in Nylon®, 4 staffe di trascinamento, 4 finecorsa regolabili PR2207, 1 guida pavimento SDL01, 2 guide mobili doppie SDZ01

Disponibile in versione destra (cod. PRTT3-100-DX) e sinistra (cod. PRTT3-100-SX)
PROFILI E ANGOLARI ESCLUSI-DA USARSI CON COPERTINA PRC02L

PANTA REI TELE-T 3 leaves dragging telescopic sliding door set composed of:
6 SD07 no cut-out low profile clamps, 6 Nylon® carriages, 4 dragging brackets, 4 adjustable PR2207 wheel stops, 1 SDL01 floor guide, 2 SDZ01 floating double guide

Right (code PRTT3-100-DX) and left (PRTT3-100-SX) models available
USE WITH PRC02L COVER

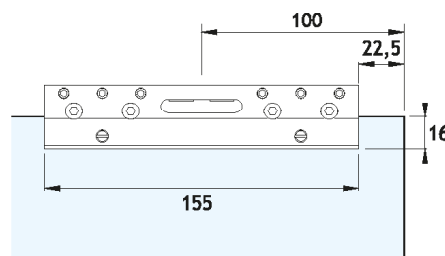
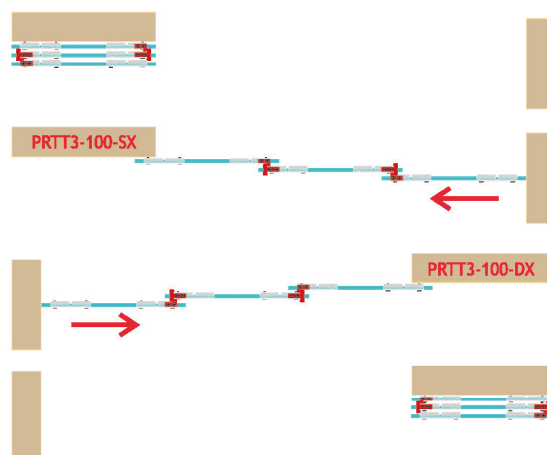

			AA	BX	XA
--	--	--	----	----	----